



DISTO™ classic⁴ / lite⁴

User Manual

Version 1.0, English

Leica
Geosystems

DISTO classic⁴ / lite⁴ hand-held laser meter

Congratulations on your purchase of a DISTO.

en



Product identification

The identification label for your product is fitted on the back. The serial number is in the battery compartment. Enter model and serial number in your User Manual, and **always refer to this information** when you need to contact your **agency or service centre**.

Model: DISTO _____

Serial no.: _____



This User Manual contains important safety instructions (see section "Safety Instructions") as well as instructions on use of the instrument. Read carefully through the User Manual before you switch on the instrument.

Symbols used

The symbols used in this User Manual have the following meanings:



DANGER:

Indicates an imminently hazardous situation which, if not avoided, will result in death or serious injury.



WARNING:

Indicates a potentially hazardous situation or an unintended use which, if not avoided, could result in death or serious injury.



CAUTION:

Indicates a potentially hazardous situation or an unintended use which, if not avoided, may result in minor injury and/or in appreciable material, financial and environmental damage.



Important paragraphs which must be adhered to in practice as they enable the product to be used in a technically correct and efficient manner.

Introduction	6	Menu / settings	14	Safety Instructions	25
Special features	6	Selecting reference setting	15	Use of the instrument	25
Area of applicability	6	Selecting units	16	Permitted use	25
Types of Instrument, Keypad	7	Measure with offset (only classic ⁴)	16	Prohibited uses	25
DISTO classic ⁴	7	Switching on/off "Beep" (only classic ⁴)	17	Limits to use	25
DISTO lite ⁴	7	Resetting (only classic ⁴)	18	Areas of responsibility	26
Display	8	Functions (only classic⁴)	18	Hazards in use	26
How to Use the Instrument	8	Fnc1 = Save values (constants)	18	Important hazards in use	26
Inserting / replacing the batteries	8	Recalling the constant	18	Laser classification	28
Switching on DISTO	9	Recall last measured value (stack)	19	Labelling	29
Switching off DISTO	9	Fnc2 = Tracking - Maximum	19	DISTO with telescopic viewfinder	30
Clear key (C)	10	Fnc3 = Tracking - Minimum	20	Electromagnetic compatibility (EMC)	30
Measuring	10	Fnc4 = Pythagoras, height measurement	20	FCC statement (applic. in U.S.)	31
Distance measurement	10	User Information	22	Care and Storage	32
Hints for measuring	10	Range	22	Care	32
Continuous measurement (tracking)	11	Rough surfaces	22	Storage	32
Laser in continuous operation	11	Transparent surfaces	22	Transport	32
Time delay release	12	Wet, smooth or high-gloss surfaces	22	Despatch	32
Calculations	12	Inclined, round surfaces	23	Technical Data	33
Area	12	Free-handed aiming	23	Remarks on measuring accuracy	34
Volume	12	In the field	23	Accuracy tests	35
Partial heights, chain values	13	Set mark for viewfinder	23	Message Codes	35
Doubling a measured value	14	Illumination	24		
		Accessories	24		

Introduction

The electronic DISTO classic⁴ / lite⁴ belong to a new generation of hand-held laser meters. Proven construction combined with modern functions make it possible to use it efficiently and for exact measuring. In this way productivity increases and costs are lowered.

en

Innovations like automatic release or maximum tracking help to make daily surveying tasks easier. The instrument is suited for width and distance measuring as well as calculating areas, volumes and segments.

The operation of the instrument's functions can be learned easily in a short space of time.

Special features

- Easy and quick to learn.
- Interactive keys; with large and clear LCD
- Small, light-weight and easy-to-use
- Trouble free quick measuring with integrated visible laser beam
- Integrated calculation functions
- Built to withstand the hazards of a construction site
- Selectable measuring units

Area of applicability

This User Manual is for the DISTO classic⁴ and DISTO lite⁴.

General descriptions are valid for all types.

Sections only valid for a specific instrument are marked accordingly.

General illustrations are of the DISTO classic⁴; generally the name DISTO is used.

DISTO classic⁴

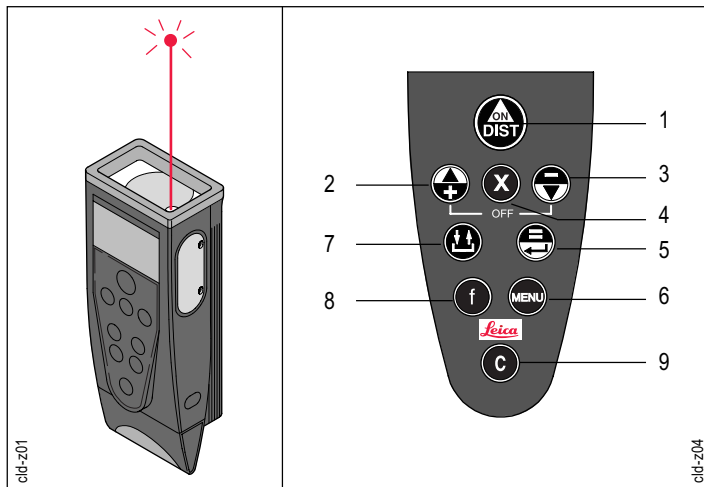

- | | |
|------------------------------------|----------------------------------|
| 1 On key and measurement key | 6 Menu / Function 2/3 |
| 2 Plus / MENU: function forward | 7 Save, Stack |
| 3 Minus / MENU: function backwards | 8 Functions |
| 4 Multiply, automatic release | 9 Clear/Clear Entry, Normal Mode |
| 5 Equals, enter | |

DISTO lite⁴

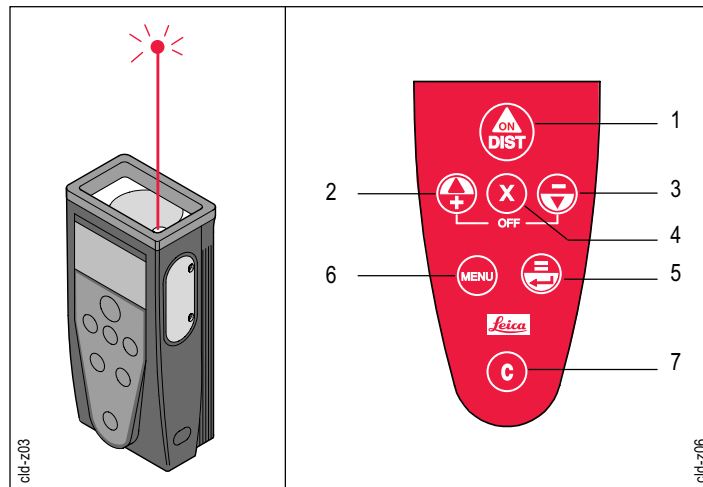

- | | |
|------------------------------------|----------------------------------|
| 1 On key and measurement key | 5 Equals, enter |
| 2 Plus / MENU: function forward | 6 Menu |
| 3 Minus / MENU: function backwards | 7 Clear/Clear Entry, Normal Mode |
| 4 Multiply, automatic release | |

en

Display

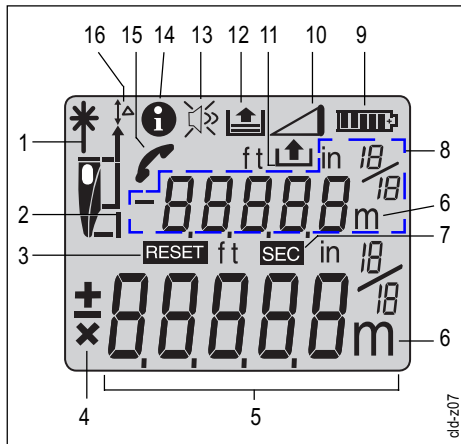

- 1 Laser "on"
- 2 Measurement reference (rear, stand, front)
- 3 Reset instrument
- 4 Display of the mathematical operators resp. math. sign
- 5 Main display (e.g. measured distance)
- 6 Units (m(mm), m(cm), ft, ft in 1/16, in, in 1/16)
- 7 Time symbol for time delay release
- 8 Auxiliary display, (e.g. previous value)
- 9 Battery display
- 10 Pythagoras function
- 11 Recall stored constant (max. 10)
- 12 Recall last 15 values
- 13 Beep (On/Off)
- 14 Information
- 15 Contact customer service
- 16 Offset setting

How to Use the Instrument

Inserting / replacing the batteries

1. Simultaneously depress the locking clips on the battery cover. Remove battery cover.

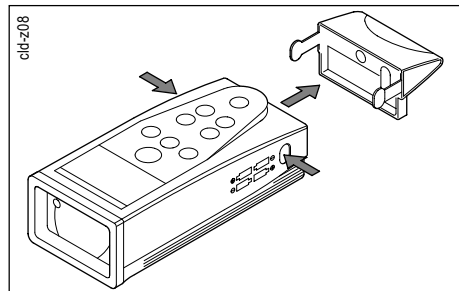

2. Replace batteries.

 If battery voltage is too low, the battery symbol appears on the display. Fit new batteries.

 **Always replace the complete battery set!**

Switching on DISTO

- Do not use old and new batteries together.
- Do not use batteries from different manufacturers or batteries of different types.
- For type of battery, refer to Technical Data.

 Fit batteries the right way round.

3. Replace battery cover. Push in and listen for locking click sound.

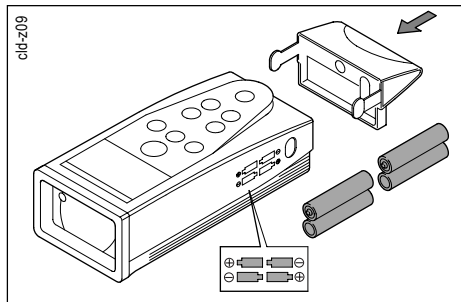



To save power, the DISTO switches off automatically after 90 seconds if no key is pressed.







Briefly press (base functions, for all keys).



The laser is switched on automatically, this symbol  starts to blink in the display.

After 30 seconds the laser shuts off automatically. To reactivate the laser press .

Switching off DISTO

- After a distance measurement (result displayed): Press both symbols  OFF  simultaneously.
- In Measuring and Tracking Modes (no result displayed):  (Clear), press  OFF  simultaneously.

 After 90 seconds the instrument shuts off automatically if:

- in this time no key was pressed,
- continuous measuring was not activated,
- the instrument was not in continuous laser measuring mode.

en

Clear key ()

The clear key resets the DISTO to Normal Mode, i.e. it is set to zero (= **Clear**).

The clear key may be pressed before or after a measurement / calculation. In Menu Mode it resets to Normal Mode.

During a function (e.g. during calculations, while setting up menus) the **last selected function is deleted** (= **Clear Entry**), if it had not been executed by pressing  .

Measuring

Distance measurement



Switch on instrument. The laser is also switched on, the instrument is in "**Pointing Mode**".



A second press starts the **distance measurement**, "**diSt**" appears briefly on the display.



The result is displayed immediately in the selected unit.



With the instrument on and the laser off, it is in "**Normal Mode**".

Hints for measuring

Measuring from edge

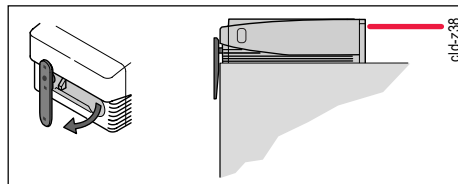

DISTO lite⁴ features a positioning bracket - for measuring from edges !

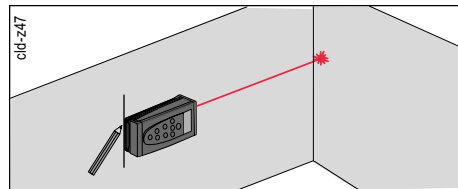

The DISTO lite⁴ is ideally suited for "marking-off ops." - e.g. when staking out distances.

Measuring from flat planes

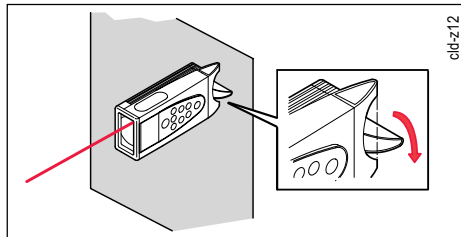

For stable measuring turn bumper 90° and place instrument on the flat plane (only classic⁴).

Measuring from corners

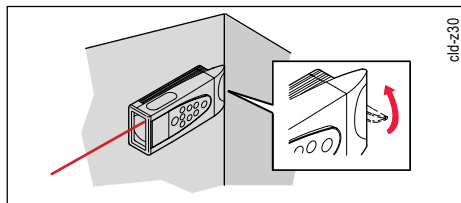

Precise measuring from corners not possible with DISTO lite⁴ !

Continuous measurement (tracking)

- Press to switch on laser.
- Press and hold until the * symbol lights up permanently and "trc" appears briefly.
- The next press starts a distance measurement and the result is displayed. DISTO then resets to Normal Mode.

Press / / to end Tracking Mode.

Example:
Stake off distance

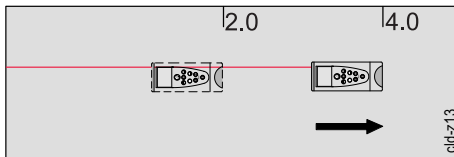

Laser in continuous operation

- In Normal Mode, press key until the * symbol is continuously illuminated and a long "beep" is heard.
- A distance measurement is triggered each time the key is pressed.
- Activates continuous measuring if user needs it ().
- Switches off instrument to end continuous laser operations.
- During continuous laser operations the laser does **not** switch off after 90 seconds !

Time delay release



Switch on laser (Pointing Mode).



Press and hold until desired time delay has been reached.

On the screen it shows "SEC" (delay) and a number (delay in seconds) appears on the display.

As long as the key is pressed, the delay is increased (max. 60 seconds).

Once the key is released, the remaining seconds (59, 58, 57 ...) are displayed, until measuring. The last 5 secs. are counted down with a "beep".

After the last "beep", the measurement is made, the value displayed.

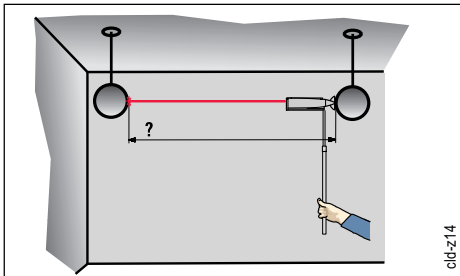

Calculations

Area

Measurement x measurement = **area**



Measurement (e.g. 3.500m)



Multiplication



Measurement (e.g. 8.375m)



= Area (e.g. 29.313m²)

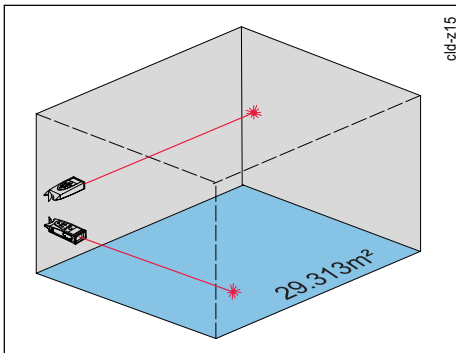

Volume

Measurement x measurement x measurement
= **Volume**



Measurement (e.g. 3.500m)



Multiplication



Measurement (e.g. 8.375m)



Multiplication







Measurement (e.g. 2.285m)



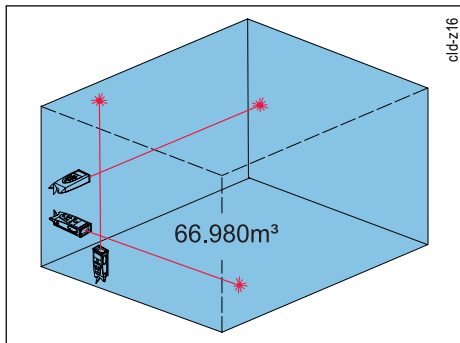

= Volume (e.g. 66.980m³)

Partial heights, chain values





👉 The volume can be calculated following an area calculation (...  = area, ,  ,  = volume).

Measurement + measurement = **sum**, e.g. of partial heights



  Measurement

 Addition



  Measurement

 = Sum



👉 In the same way **chain values** (= any amount of distance measurements) and **sums of area/volumes** can be added up.

👉 During calculations pressing "Clear-Entry" () is available as long as the function has not been executed by pressing  !

Measurement - measurement = **difference**

  Measurement

 Subtraction

  Measurement

 = Difference

Doubling a measured value

It is easy to double the measured values, e.g. to determine the length of the walls in a room:

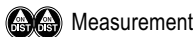

Measurement



Addition



Measurement



= Sum (= half the length of the walls)



Repeat, double measured value
(= circumference).

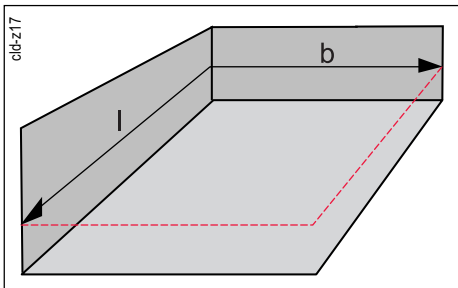

Menu / settings

With the help of the menu the user can configure the instrument to his/her own specific and personal needs.

Possible settings:

• DISTO classic⁴

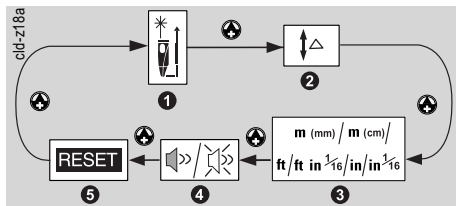

- 1 Setting reference
- 2 Measure with offset (add/reduce)
- 3 Selecting measuring units
- 4 Beep (on / off)
- 5 Reset



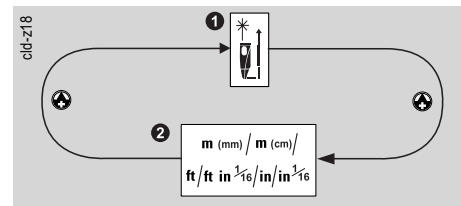







• DISTO lite⁴











- 1 Setting reference
- 2 Selecting measuring units

Selecting reference setting

Calling up a menu:

-  Switch on DISTO.
 -  Set to normal mode.
 -  Call up menu,  is displayed.
 -  Press until desired menu screen appears or
 -  switch between the various menus.
 -  Confirm selection, activate menu point.
 -  Make desired selection.
 -  Confirm setting, reset to Normal Mode.
-  "Clear Entry" may also be used (e.g. to cancel a selection).

Permanent reference setting

-   Press until  and  appear in the display.
-  Confirm selection,  starts to blink.
-  /  Select reference setting.
-  Confirm selection, reset to Normal Mode. All subsequent measurements are in reference to this setting !

Possible settings:

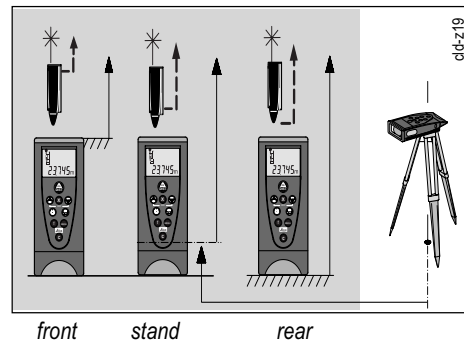

en

Selecting reference setting, contd.

Reference setting only for one measurement

 Switch on DISTO,  starts to blink.

 Select reference setting:

front , stand , rear .

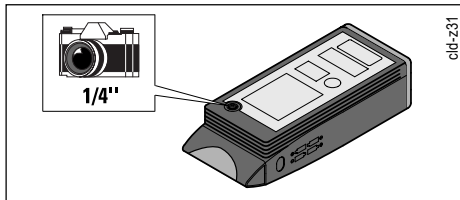

 Start measurement.

 The result is displayed with a blinking "reference setting" as indication that "rear reference" is not selected.





 At the back of the instrument is a 1/4" camera thread.

Selecting units

  Press until the desired unit (e.g. 0.000m) and  are displayed.

 Confirm selection, the selected unit starts to blink.

 Select unit.

 Confirm selection, reset to Normal Mode.



Selectable units:

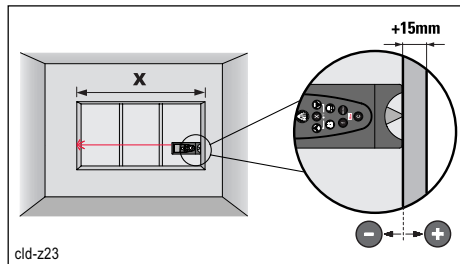

- m (mm) = 0.000 m
- m (cm) = 0.00 m
- ft = 0.00 ft
- ft in 1/16 = 0 ft 0 in^{1/16}
- in = 0.0 in
- in 1/16 = 0 in^{1/16}

Measure with offset (only classic^d)





 Press until  and  are displayed.

 Confirm function,  starts to blink.



 Set desired offset (=shifting reference) (e.g. 0.015m); quick set by keeping key  pressed. For larger steps press .

Offset can be positive (add) or negative (reduce)!

Measure with offset (only classic⁴), contd.



 Confirm selection (or cancel with , ).

To indicate that an offset has been set, the  symbol is displayed continuously (offset \neq 0).

  Measure. Subject to set offset, the measured results are displayed.

 Using this function you can measure with rough size, as an example !

Please make this a rule:

 After rough size measurement always set DISTO to offset 0.000 :
Call function as described, then , .

 After making or changing settings, it is imperative that a test measurement is performed.

 **Using the offset edge measurements can be made correctly.**

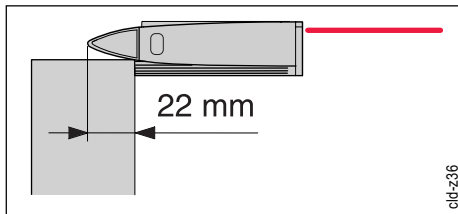

Input of offset: -22mm (-0.022m). Otherwise, wrong measurements are the result.



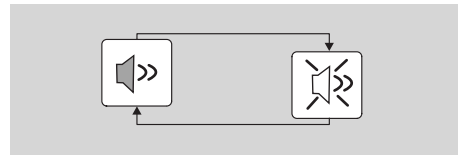



Switching on/off "Beep" (only classic⁴)





en

 Press until  and  appear in the display.

 Confirm selection, the current setting appears in the display (flashing).











 /  Select on () / off ().

 Confirm selection, reset to Normal Mode.

 With Beep switched off the symbol  is permanently displayed.













Resetting

(only classic⁴)







-  Press until  and **RESET** appear in the display.
-  Confirm selection, **RESET** starts blinking and  is permanently displayed.
-  Select components to be reset. To choose from:
 - stack and constant   (are deleted) or
 - only stack  (is deleted) or
 - stack and constant   (are deleted) and
 - reference (rear) and
 - offset (=0) and
 - Beep (On) and
 - unit (meter)
-  Selected components are reset, back to Measuring Mode.

Functions (only classic⁴)







Fnc1 = Save values (constants)

- Measure and calculate desired values (e.g. **height of room**, area, volume).
-   Press until **Fnc 1** and  start to blink.
 -  /  If desired, adjust value (e.g. from 2.297m to 2.300m) - for larger steps additionally press  .
With  the unit can be adjusted. The adjustment is for m, m² and m³ resp. ft, ft² and ft³ only.
 -  Press,  and a number (=memory location) starts to blink.
 -  /  Select memory location.
 -  Save value.

Recalling the constant



-  Press briefly,  and the contents of the first constant memory location are displayed (e.g. 2.300m).
-  /  Select desired value (1 to 10).
-  Confirm, value is ready to be used for (e.g. calculating an area) or
-  Cancel function.

Recall last measured value (stack)

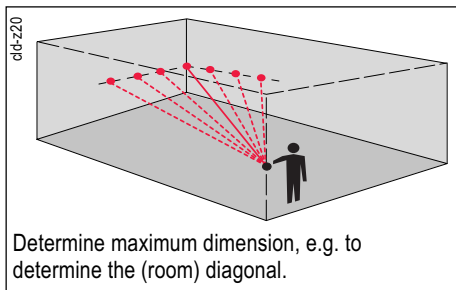

-  Press briefly,  and the contents of the first constant memory location are displayed.
-  Press again, stack is activated and  is displayed.
-  Select desired value (max. 15!).
-  Confirm, value is ready to be used for (e.g. calculating an area) or
-  Cancel function.

Fnc2 = Tracking - Maximum



  Press, **Fnc 2** and  are displayed

or

 /  switch between the functions.

 Confirm function. Laser is on (Pointing Mode).

Aim with the DISTO at a point to the left / right of the corner.



Activate continuous measurement with a brief press.

Slowly rotate the DISTO to the right / left past the corner.







Stop continuous measurement.

The **largest measurement** is displayed (e.g. 12.314m = diagonal of the room).

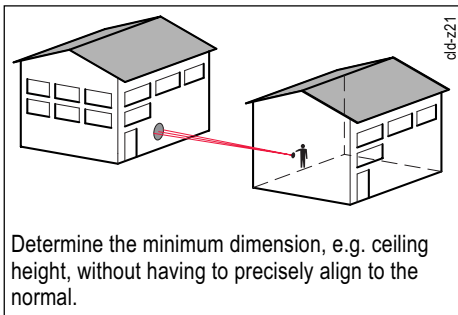
en

Fnc3 = Tracking - Minimum



-   Press repeatedly until **Fnc 3** and **H** appear.
-  Confirm function. Laser is on (Pointing Mode).
Aim DISTO approximately at the target point.
-  Activate continuous measurement with a brief press.



Move the DISTO a large amount around the target point.



Stop continuous measurement.









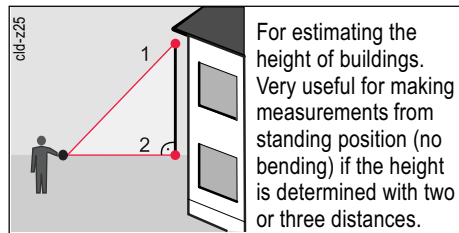

The **smallest measurement** is displayed (e.g.. 3.215m = height of the room).



Both planes (e.g. floor/ceiling, walls) must be nearly parallel to each other.

Fnc4 = Pythagoras, height measurement



-   Long press until **Fnc 4** and  appear on the display.
-  Confirm function, "1 ---" appears on the display.
Aim at the upper point. (1).
-  Trigger measurement; **do not move the instrument!**
-  Accept value, "2 ---" appears on the display.
Point the DISTO approximately horizontally (2).
-   Long press, a minimum continuous measurement is initiated.
-   Press briefly, a direct measurement is triggered.

Fnc4 = Pythagoras, ... contd.



Move the DISTO a large amount around the ideal measurement point.



/ **C** / Stop of continuous measurement.



Accept value, "3 ---" appears on the display.



End function, the height and distance are displayed from **two measurements** (Pythagoras).

Or:

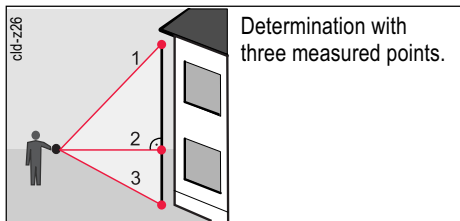

Aim at third point.



Trigger measurement.



End function, the height and distance are displayed from **three measurements** (Pythagoras).

Alternative:

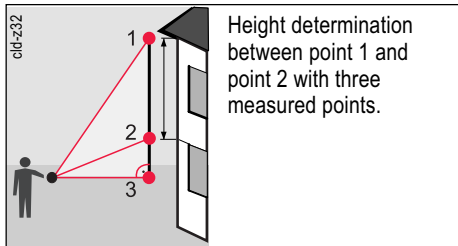

Press until **Fnc 4** and appear on the display.



Confirm function, "1 ---" appears on the display.

Aim at the upper point. (1).



Trigger measurement; **do not move the instrument!**



Accept value, "2 ---" appears on the display.

Aim at second point.(2).



Trigger measurement; **do not move the instrument!**



Accept value, "3 ---" appears on the display. Point the DISTO approximately horizontally (3).



Long press, a minimum continuous measurement is initiated.



Move the DISTO a large amount around the ideal measurement point.



/ **C** / Stop continuous measurement.



End function, the height, width between **point 1 and 2** (Pythagoras) are displayed



The measuring sequence must be adhered to in any case!









Function can also be used for **width measurements!**



All three (two) points must be on a vertical (horizontal) line in the plane of the wall!

 With each of the distance measuring you can:

- make a simple **distance measuring** () or
- use a **value form stack** () or
- **continuous measurement minimum** ( ) or
- a **measurement with time delay release** ().

 For short distances, a good base behind the instrument is sufficient for mechanical alignment.

 You will obtain the best results if the DISTO is rotated around a fixed point (rear edge, thread position) and the axis of the laser beam passes through this axis. So do not simply place on a camera tripod, in this case the axis of the laser beam is approx. 70 to 100mm **above** the centre of rotation, this can lead to significant variations in the height.

Range

In daylight (outdoors) always work with laser viewfinder. If necessary, shade the target.

Increased ranges:

At night, at dusk and when target area is in the shade.

Reduced range:

The range of the DISTO can be reduced by matt, green and blue surfaces (also by trees or plants).

Rough surfaces

On a rough surface (e.g. coarse plaster) a mean value is indicated.

To avoid measuring to the bottom of plaster joints: Use target plate, 3M "Post-it" or board.

Transparent surfaces

To avoid measuring errors, do not measure towards colorless liquids (like water) or (dust free) glass. For materials and liquids unfamiliar to you always take a trial measurement.

 When aiming through panes of glass, or if there are several objects in the line of sight, erroneous measurements can occur.

Wet, smooth or high-gloss surfaces

1. Aiming at a "flat" angle deflects the laser beam. The DISTO may receive a signal that is too weak (error message E 255).
2. If aiming at a right angle, the DISTO may receive a signal that is too strong (error message E 256).

Inclined, round surfaces

Can be measured with the laser:

Requirement: There is enough area on the target surface for the laser spot.

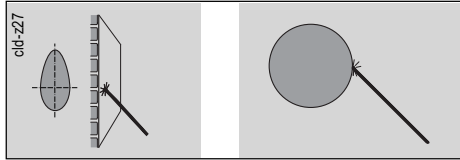

Free-handed aiming

(approx. 20 - 40 m):

Use target plate 563875 (DIN C6) resp. 723385 (DIN A4) or:

Make your own target plates of any size:

Distance:	Order:
to 30 m (white)	Scotch Cal*
30 - 100 m (brown)	Engineering-Grade 3279 (7502 99 61 036)*

* Manufacturer 3MCompany

In the field

Attach the telescopic viewfinder, and check it is engaged by applying pressure from the side.

Setting the telescopic viewfinder

1.  Keep pressed, laser on continuously (*).
2. Set up indoors, 5m, 10m or 30m from a wall.
3. Turn eyepiece slowly until crosshair and laser spot are sharply focused.



4. Use the two screws (side, height) to adjust the laser spot.

Example: You are positioned exactly 5m in front of a wall (approx. $\pm 0.5m$). The laser spot must be in the centre, exactly beside the 5m distance mark. In the field check adjustment from time to time. (in the half-shade about 10-15m).

Aim with and without the red filter in position (visibility is increased).

Set mark for viewfinder

Setting mark for adjusting the telescopic viewfinder.

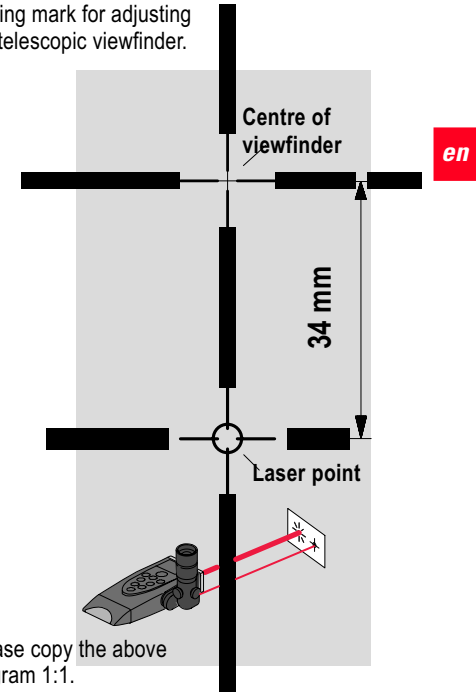

Please copy the above diagram 1:1.

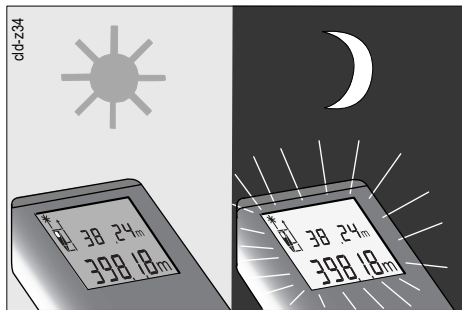

Thanks to fluorescence, you can also see your result in the dark. If the display is placed under a light source (daylight, artificial light), it will illuminate for more than 15 minutes! Without consuming any power!

Telescopic viewer (667478)

For simple aiming operations, out in the open. For highly accurate aiming while far away from the object. The laser spot on the object can be seen particularly well in shaded areas after slewing in the red filter.

Wrist strap (667491)

- safeguard against dropping,
- prevents injury.

Attach to fastening thread (1/4").

Adjust loop:

- So that DISTO does not slip from the wrist.
- Loop does not need to be re-adjusted every time.

Shoulder strap (563879)

Fasten to hand loop clip; adjustable over a wide range.

DISTO-clip (714871)

With this clip your DISTO hangs comfortably on your belt or waistband and is easily reached.

Carrying pouch (667169)

Large black carrying pouch for transportation and protection.

Compartments for user manual, telescopic viewfinder and palmtop computer.

Level (667158)

For horizontal and vertical aiming, e.g. if floor or wall is highly uneven.

Aiming accuracy about 1°, corresponding to a measuring error of only about 5mm at 30m.

DISTO with this level is not a laser level!

Target plate 563875 (DIN C6) / Target plate 723385 (DIN A4)

For poorly reflecting surfaces, **white side up to 40 - 50m**, over this distance the brown side with the special reflection layer.

Up to over 100m: Combine several plates to one large target area.

Holster (667489)

For max. protection. Fitted to belt.

Safety Instructions

The following directions should enable the person responsible for the DISTO, and the person who actually uses the instrument, to anticipate and avoid operational hazards.

The person responsible for the instrument must ensure that all users understand these directions and adhere to them.

Use of the instrument

Permitted use

The permitted uses of the DISTO are the following:

- Measuring distances
- Computing areas and volumes
- Storing measurements

Prohibited uses

- Using the instrument without instruction
- Using outside the stated limits
- Deactivation of safety systems and removal of explanatory and hazard labels
- Opening of the equipment by using tools (screwdrivers etc.), as far as not specifically permitted for certain cases
- Carrying out modification or conversion of the product
- Use after misappropriation
- Use of accessories from other manufacturers without the express approval of Leica Geosystems
- Deliberate or irresponsible behaviour on scaffolding, when using ladders, when measuring near machines which are running, or near parts of machines or installations which are unprotected
- Aiming directly into the sun
- Deliberate dazzling of third parties; also in the dark
- Inadequate safeguards at the surveying site (e.g. when measuring on roads, etc.)



WARNING:

Prohibited use can lead to injury, malfunction, and material damage. It is the task of the person responsible for the instrument to inform the user about hazards and how to counteract them. The DISTO is not to be operated until the user has been instructed.

Limits to use



See section "Technical Data"

Environment:

Suitable for use in an atmosphere appropriate for permanent human habitation. Cannot be used in an aggressive or explosive environment. Use in rain is permissible for limited periods.

en

Areas of responsibility

Responsibilities of the manufacturer of the original equipment Leica Geosystems AG, CH-9435 Heerbrugg (Leica Geosystems):

Leica Geosystems is responsible for supplying the product, including the User Manual and original accessories, in a completely safe condition.

Responsibilities of the manufacturer of non-Leica accessories:



The manufacturers of non-Leica Geosystems accessories for the DISTO are responsible for developing, implementing and communicating safety concepts for their products. They are also responsible for the effectiveness of these safety concepts in combination with the Leica Geosystems equipment.

Responsibilities of the person in charge of the instrument:



WARNING:

The person responsible for the instrument must ensure that the equipment is used in accordance with the instructions. This person is also accountable for the deployment of personnel and for their training and for the safety of the equipment when in use.

The person in charge of the instrument has the following duties:

- To understand the safety instructions on the product and the instructions in the User Manual.
- To be familiar with local safety regulations relating to accident prevention.
- To inform Leica Geosystems immediately if the equipment becomes unsafe.

Hazards in use

Important hazards in use



WARNING:

The absence of instruction, or the inadequate imparting of instruction, can lead to incorrect or prohibited use, and can give rise to accidents with far-reaching human, material, financial and environmental consequences.

Precautions:

All users must follow the safety instructions given by the manufacturer and the directions of the person responsible for the instrument.



CAUTION:

Watch out for erroneous distance measurements if the instrument is defective or if it has been dropped or has been misused or modified.

Precautions:

Carry out periodic test measurements. Particularly after the instrument has been subject to abnormal use, and before, during and after important measurements.

Make sure the DISTO optics is kept clean and that there is no mechanical damage to the bumper.

 **CAUTION:** Take care when aiming the DISTO directly into the sun. The receiver lens acts as a magnifying glass and can thus cause damage to the instrument internals.

Precautions:
Do not aim the DISTO directly at the sun.

 **WARNING:** Insufficient securing or marking of your measurement site could cause a dangerous situation on the public highway, building site, or in the factory etc.

Precautions:
Always ensure your measurement site is appropriately secured. Obey the local accident prevention regulations, and road safety rules, at all times.

 **CAUTION:** In using the instruments for distance measurements or for positioning moving objects, (e.g. cranes, building equipment, platforms etc.) unforeseen events may cause erroneous measurements.

Precautions:
Only use this product as a measuring sensor, not as a control device. Your system must be configured and operated in such a way, that in case of an erroneous measurement, malfunction of the device or power failure due to installed safety measures (e.g. safety limit switch), it is assured that no damage will occur.

 **CAUTION:** On sending the instrument, or on the disposal of batteries that are not fully discharged, a fire could be caused by improper treatment.

Precautions:
Remove the batteries from their compartment before sending the instrument. Dispose of batteries only if they are completely discharged (operate the instrument in tracking mode, until batteries are completely discharged).

 **CAUTION:** If you do not intend using your instrument for a long time, the batteries may leak and damage your equipment!

Precautions:
Remove batteries if you are not going to use the instrument for an extended period.

 **CAUTION:** If the accessories used with the instrument are not properly secured, and the equipment is subjected to mechanical shock (e.g. blows, falling etc.), the equipment may be damaged, safety devices may be ineffective or people may sustain injury.

Precautions:
When setting-up the instrument, make sure that the accessories (e.g. telescopic viewer, wrist strap, shoulder strap, etc.) are correctly adapted, fitted, secured and locked in position. Avoid subjecting the equipment to mechanical shock.



WARNING:

If the equipment is improperly disposed of, the following can happen:

- If plastic parts are burnt, poisonous gases are produced which may impair health.
- If batteries are damaged or overheated, they can explode and cause poisoning, burning, corrosion or environmental contamination.
- By disposing of the equipment irresponsibly you may enable unauthorized persons to use it in contravention of the regulations, exposing themselves and third parties to the risk of severe injury and contaminating the environment.

Precautions:

Dispose of the equipment appropriately in accordance with the regulations in force in your country. Always prevent access to the equipment by unauthorized personnel.

Laser classification

The DISTO produces a visible laser beam which emerges from the front of the instrument.

It is a Class 2 laser product in accordance with:

- IEC60825-1 : 1993 "Radiation safety of laser products"
- EN60825-1 : 1994 "Radiation safety of laser products"

It is a Class II laser product in accordance with:

- FDA 21CFR Ch.I §1040 : 1988 (US Department of Health and Human Service, Code of Federal Regulations)

Laser Class 2/II products:

Do not stare into the laser beam or direct it towards other people unnecessarily. Eye protection is normally afforded by aversion responses including the blink reflex.



WARNING:

Looking directly into the beam with optical aids (e.g. binoculars, telescopes) can be hazardous.

Precautions:

Do not look directly into the beam with optical aids.



CAUTION:

Looking into the laser beam may be hazardous to the eyes.

Precautions:

Do not look into the laser beam. Make sure the laser beam is aimed above or below eye level. (particularly with fixed installations, in machines, etc..)

Labelling

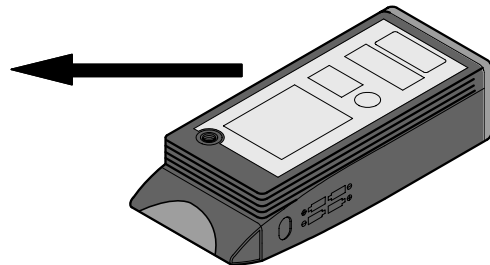
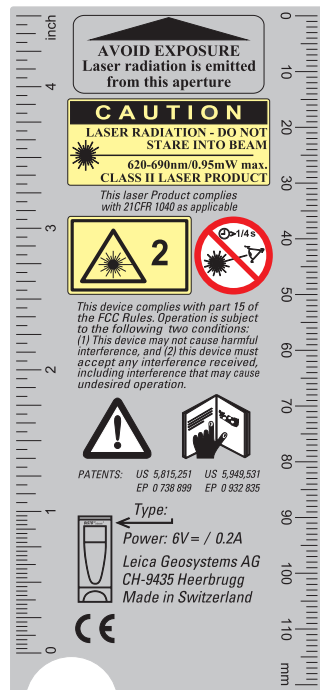
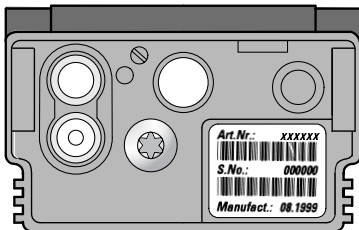
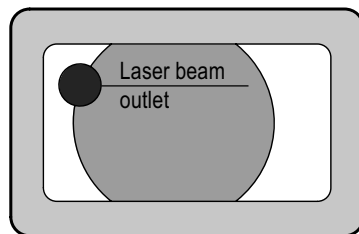
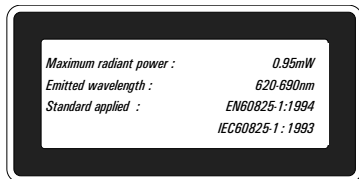

en

Beam divergence:	0.16 x 0.6 mrad
Pulse duration:	15 x 10 ⁻⁹ s
Maximum radiant power: * Measurement uncertainty:	0.95 mW* ±5%
Maximum radiant power per pulse:	8 mW

CAUTION:
 Allow only authorized Leica Geosystems service workshops to service the instruments.



WARNING:

Looking right at the reflected laser beam in a DISTO operated with telescopic viewfinder could be dangerous when you aim at areas that reflect like a mirror, or emit reflections unexpectedly (e.g. a mirror, metallic surfaces, windows, prisms, liquids).

Precautions:

If you are using a telescopic viewfinder, do not aim at areas that are reflective like a mirror, or which could produce unintended reflections (e.g. mirrors, metallic surfaces, windows, prisms).

The term "electromagnetic compatibility" is taken to mean the capability of the DISTO to function smoothly in an environment where electromagnetic radiation and electrostatic discharges are present, and without causing electromagnetic interference to other equipment.



WARNING:

Electromagnetic radiation can cause interference in other equipment. Although the DISTO meets the strict regulations and standards which are in force in this respect, Leica Geosystems cannot completely exclude the possibility that interference may be caused to other equipment.



CAUTION:

Interference caused by electromagnetic radiation can result in the tolerance limits for measurements being exceeded. Although the DISTO meets the strict regulations and standards which are in force in this respect, Leica Geosystems cannot completely exclude the possibility that interference may be caused to the DISTO by very intensive electromagnetic radiation, for instance near radio transmitters, walkie-talkies, diesel generators etc. Under such conditions, check measurement results for their plausibility.

FCC statement (applic. in U.S.)

WARNING: This equipment has been tested and found to comply with the limits for a Class B digital device, pursuant to part 15 of the FCC Rules. These limits are designed to provide reasonable protection against harmful interference in a residential installation.

This equipment generates, uses and can radiate radio frequency energy and, if not installed and used in accordance with the instructions, may cause harmful interference to radio communications.

However, there is no guarantee that interference will not occur in a particular installation.

If this equipment does cause harmful interference to radio or television reception, which can be determined by turning the equipment off and on, the user is encouraged to try to correct the interference by one or more of the following measures:

- Reorient or relocate the receiving antenna.
- Increase the separation between the equipment and receiver.

- Connect the equipment into an outlet on a circuit different from that to which the receiver is connected.
- Consult the dealer or an experienced radio/TV technician for help.

WARNING: Changes or modifications not expressly approved by Leica Geosystems for compliance could void the user's authority to operate the equipment.

Product labelling:

This device complies with part 15 of the FCC Rules. Operation is subject to the following two conditions: (1) This device may not cause harmful interference, and (2) this device must accept any interference received, including interference that may cause undesired operation.

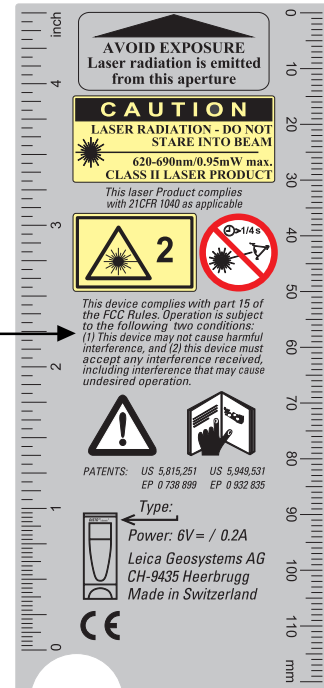

en

Care and Storage

Care

Clean and dry

- Blow away dust from lenses.
- Do not touch glass with fingers.
- Only clean with a soft cloth; if necessary, damp with pure alcohol.

Do not use other cleaning agents. Plastic parts could be affected.

Wipe off splashes of cement, plaster, etc. as quickly as possible, using water and a damp cloth or sponge. Look after the optical surfaces with the same care that you would apply to spectacles, cameras and field glasses.

Storage

 Please respect the temperature limits, specially during summer when storing the equipment inside a vehicle.
(-40°C to +70°C / -40°F to +158°F)

 Unpack instruments and accessories that have become wet. Dry off the instrument, container and accessories (at maximum 40 °C / 108°F) and clean. Only repack the equipment when it is completely dry.

 After longer periods of storage or transport carry out a check measurement before using the equipment.

If the indoor and outdoor temperatures are very different, allow time for the instrument to adapt.

If the DISTO is removed from an air-conditioned room and exposed to warm damp air, the instrument and the optics will fog over. To reduce this effect, cover the instrument with a cloth and allow it to adapt slowly to the new conditions as you would for a camera or a video.

Transport

The holster protects the DISTO well against mechanical shock, but not against water or dust. It is recommended that you always transport the DISTO in the holster or an equivalent protective container or packaging.

Do not exceed the temperature limits. Before embarking on a flight, enquire whether you are permitted the DISTO as hand luggage.

Despatch

 Always use the original Leica Geosystems packaging (holster and shipment box) for sending the instrument. You must remove the batteries (send the instrument **without** batteries).

Technical Data

	DISTO classic	DISTO lite
Measuring accuracy	typ.: ± 3mm / max.: ± 5mm *	typ.: ± 3mm / max.: ± 5mm *
Smallest unit displayed	1mm	1mm
Range	0.3m to over 100m **	0.3m to over 100m **
Time for a measurement dist / trc	0.5...ca.4s / 0.16...ca.1s	0.5...ca.4s / 0.16...ca.1s
Laser	visible; 635nm	visible; 635nm
Ø Laserspot (at distance)	6 / 30 / 60 mm (10 / 50 / 100 m)	6 / 30 / 60 mm (10 / 50 / 100 m)
Outdoor measurements (adaption for viewfinder)	✓	✓
Illumination (fluorescent display)	✓	✓
Two line display	✓	✓
Multifunctional bumper	✓	No
Time delay release, pocket calculator	✓, ✓	✓, ✓
Tracking	✓	✓
FNC1, Constant	10 values	No
FNC2, Continuous measurement max.	✓	No
FNC3, Continuous measurement min.	✓	No
FNC4, Pythagoras	✓	No
Memory (Stack)	15 last values	No
Battery, Type AAA, 4x1,5V	over 3000 measurements	over 3000 measurements
Splash and dust proof	IP54 acc. IEC529: Splash proof, Dust proof	IP54 acc. IEC529: Splash proof, Dust proof
Dimensions, Weight	172 x 69 x 44 mm, 360 g	154 x 69 x 44 mm, 360 g
Temperature range Storage Operating	-40°C to +70°C (-40°F to +158°F) -10°C to +50°C (-14°F to +122°F)	-40°C to +70°C (-40°F to +158°F) -10°C to +50°C (-14°F to +122°F)

en

Remarks on measuring accuracy

* The measuring accuracy corresponds to the ISO-recommendation ISO/R 1938-1971 with a statistical confidence level of 95% (i.e. \pm twice the standard deviation). The typical measuring accuracy relates to average conditions for measuring within the specified range. It is not valid for the user functions Fnc 2, 3, 4, and is not valid in the Tracking Mode. The maximum measuring error relates to unfavourable conditions such as:

- highly-reflecting surfaces (e.g. reflector tapes),
- operating at the limits of the permitted temperature range, adaption to ambient temperature interrupted. (page 32)
- very bright ambient conditions, strong heat shimmer and can be up to ± 5 mm (twice the standard deviation).

** At long range ± 30 ppm (± 3 mm/100 m) plus short range error.

Range increases, the better the laserlight is reflected from the target area (diffuse, not reflective), and the brighter the laserpoint is compared to the surrounding luminosity (indoors, dawn).

From approx. 40 - 50 m use target plate, brown side (page 24)

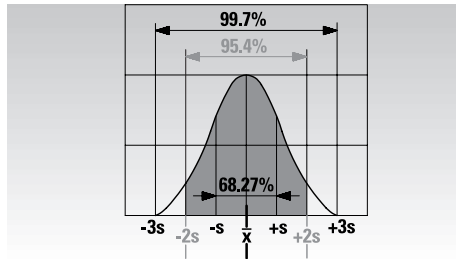

Possible method of calculating the standard deviation **s**:

When using a computer with a statistical function or if you use the program Excel, you can calculate the mean value \bar{x} and the standard deviation **s** directly from the 10 measured values.

Formula for the standard deviation **s**:

$$s = \sqrt{\frac{1}{n-1} \sum_{i=1}^n (x_i - \bar{x})^2}$$

- n ... number of measurements
 x_i ... individual value of a series of measurements
 \bar{x} ... mean value of a series of measurements

Calculation using the program Excel:

On the Insert menu, choose Functions.

Select category: Statistics and Function:STABW within the Function Assistant.

Depending on the version of Excel and the language used, the names of the menu may vary.

Accuracy tests

Accuracy tests on the DISTO for users certified to ISO 900...:

You can perform your own accuracy tests on the DISTO to meet the requirements of ISO 900... for measuring equipment.

Take a fixed, invariable, and conveniently accessible distance of about 1m to 10m, such as the width of a window opening or of a room. Measure it ten times.

Determine the magnitude of this distance with a means of measurement that is monitored by a national, accredited calibration institute (traceability back to national standards).

Determine the amount that the measurements vary from the nominal distance, and compute the standard deviation (page 34).

Record the standard deviation and set a date for the next test.

Repeat these tests at frequent and regular intervals, also before and after important measuring jobs.

Affix an adhesive label on the DISTO for accuracy tests of measuring equipment and keep a detailed record of the test procedure.





Your DISTO meets the specified accuracy if standard deviation remains smaller or equal to the typical specified value.

A DISTO whose measuring accuracy has been tested over a test distance works within the specified tolerance over the entire distance and temperature range specified in the manual.

Please note the technical data and the description of measuring accuracy in the manual (page 34).

Message Codes

Message Code	Cause	Remedy
204	Calculation error	Repeat procedure
252	Temperature above 50°C (measuring)	Cool down instrument
253	Temperature below -10 °C (measuring)	Warm up instrument
255	Receiver signal too weak, Measurement time too long Distance < 250 mm	Use target plate Measurement time > 10 sec.
256	Receiver signal too powerful	Use target plate (correct side)
257	Wrong measurement, ambient brightness too high	Use target plate
	All other messages	Call service "System"

In case of  messages switch on/off instrument several times and check if message is still displayed. Then call service and specify the message displayed. Reset message with  or   (quick-switch off).

en

Leica Geosystems AG, Heerbrugg, Switzerland has been certified as being equipped with a quality system which meets the International Standards of Quality Management and Quality Systems (ISO standard 9001) and Environmental Management Systems (ISO standard 14001).



*Total Quality Management -
Our commitment to total customer satisfaction*

Ask your local Leica Geosystems agent for more information about our TQM program.

Pat. No.

- | |
|---|
| <ul style="list-style-type: none">• US 5,815,251• US 5,949,531 |
| <ul style="list-style-type: none">• EP 0738 899• EP 0932 835 |

723865-1.0.0en/fr/es/pt

Printed in Switzerland - Copyright Leica Geosystems AG,
Heerbrugg, Switzerland 2001
Translation of original text (723881-1.0.0de)

Leica
Geosystems

Leica Geosystems AG
CH-9435 Heerbrugg
(Switzerland)
Phone +41 71 727 31 31
Fax +41 71 727 46 73
www.leica-geosystems.com